

VERTEX

Water Products

PureWaterCooler™

Water Dispenser

**OWNERS INSTALLATION
MANUAL**

Models

PWC-600/2000/3500

3 Temp - Room, Hot, Cold

PWC-500/1000/1010/1500/1800

2 Temp - Hot, Cold



VERTEX WATER PRODUCTS

Montclair, CA - USA

WARNING

1) Installing this cooler in an area where water may cause severe or costly damage is not recommended. If installation of this cooler is in an area where incidental water spillage may cause severe or costly damage it is recommended that a water detector and shut-off valve accessory be installed as well. Vertex P/N LC-8021

2) Water supply connection to coolers are to be made with the flexible plastic LDPE tubing. If connecting a hard copper line to cooler connection the Bulkhead fitting on back of cooler must be replaced with a proper metal fitting.

3) Do not position the cooler where it can be hit or bumped by Vacuum cleaners or floor waxing machines. This can cause breaks in the waterline, connection fittings and compressor tubing.

Table of Contents

1.0 Introduction	pg. 2
2.0 Receiving	pg. 3
3.0 Description, Model 2000 and 3500	pg. 3
4.0 Operation	pg. 10
5.0 Description, Model 1000 and Model 1010	pg. 12
6.0 Other Models 500/600/1: 00'000'	pg. 15
7.0 Optional Features	pg. 18
8.0 Filter Replacement	pg. 18
9.0 Cleaning and Maintenance	pg. 20
10.0 Trouble Shooting	pg. 21
11.0 Specifications	pg. 22
12.0 Warranty	pg. 23

List of Figures

Figure 1. Assembly Drawing, Model PWC 2000 and PWC 3500 ..	pg. 4
Figure 2. Flow Schematic	pg. 5
Figure 3. Filter Schematic	pg. 5
Figure 4. Installation Precautions	pg. 6
Figure 5. Water Connections	pg. 7
Figure 6. Drain Connections for RO filter	pg. 8
Figure 7. Quick Connect Fittings	pg. 9
Figure 8. Model 1000 Assembly	pg. 12
Figure 9. Water Connection / 1000	pg. 13
Figure 10. Front of Model 1000 cooler with door opened	pg. 14
Figure 11. RO Membrane Installation	pg. 19

1.0 INTRODUCTION

The VERTEX Pure Water Cooler products are a means to produce and dispense good-tasting, safe water without using “bottles of stored water”.

The Pure Water Cooler taps into your city or well water supply to efficiently filter out tastes and odor, and to remove molecular contaminants by using reverse osmosis technology: The Models are:

2000 and 3500 Model. These are 3-temperature units which provides room temperature filtered water, chilled (cold) water, nominally at 44°F, and hot water, nominally at 180°F. In addition, it has a re-boil function which brings the hot water to boil temperature of 212°F. There is also a room temperature spigot.

4/Vgo r Modem. This is a two temperature unit which provides chilled water nominally at 44°F and dispenses hot water at nominally 180°F.

1010 Model. This provides chilled water at nominally 44°F and room temperatures. No hot water is provided.

All three models are made as “R” or “F” versions. The “R” versions have reverse osmosis filtration which makes good tasting, safe water from city or well water. This consists of a 5-micron sediment filter, a carbon (GAC) 10-micron filter and a 50-gallon per day RO membrane. The filters remove sediment and dirt and the taste and odor of chlorine and other contaminants. The reverse osmosis stage removes molecular contaminants from the water. The “R” version requires a drain line connection to the drain trap to remove rejected water to the sewer.

The “F” version has the sediment and carbon filters, but not the RO membrane; therefore, it does not require a drain line connection.

CAUTION: The filter version “F” must be used only with softened water or water that has less than 3.5-grains of hardness to prevent scaling and premature burnout of the heating elements.

There are 3 other models, all versions of the basic models described above:

500 Model. This is a countertop model of the Model 1000 2-temperature system.

600 Model. This is a countertop model of the Model 2000 3-temperature system.

The above three models do not have filters; they require that the pure water be made externally and supplied to the Pure Water Cooler. An option is available which adds a filterpack system that can be mounted on the backside of the cooler.

Please read all the instructions in this manual before operating this unit.

2.0 RECEIVING THE COOLER

2.1 Unpacking (All Models)

The *PureWaterCooler™* is shipped completely assembled and ready to operate. Remove the top of the box and slide the *PureWaterCooler™* out and save the box and packing materials.

2.2 Inspection

Inspect the cooler for shipping damage. Look at the exterior panels to see if they have been dented or damaged. Check the dispensing spigots in the front. Open the bottom panel to assure that the filter system is intact. For Model 2000 only look below the filter assembly in the back to see if the compressor is secure and has not broken from the mounting. Inspect filter system to see that nothing is damaged or dislodged from shipping.

3.0 Description (Model 2000 and 3500)

3.1 Description

The assembly drawing is shown in Figure 1. The Model 2000/3500 *PureWaterCooler™* has 3 tanks. There is a main holding water tank with float valve mechanism which controls a solenoid valve on the water feed line to maintain a constant level of filtered water. There is a separate hot tank with internal heaters and a cold tank, cooled by external coils. The hot tank is at the top level of the cooler, and has a vent hole to permit hot water vapors to exit. The cold tank is lower inside the cabinet. Both tanks are fed by gravity from the main holding tank. The controls for the cooler are on the front panel as shown in Figure 1.

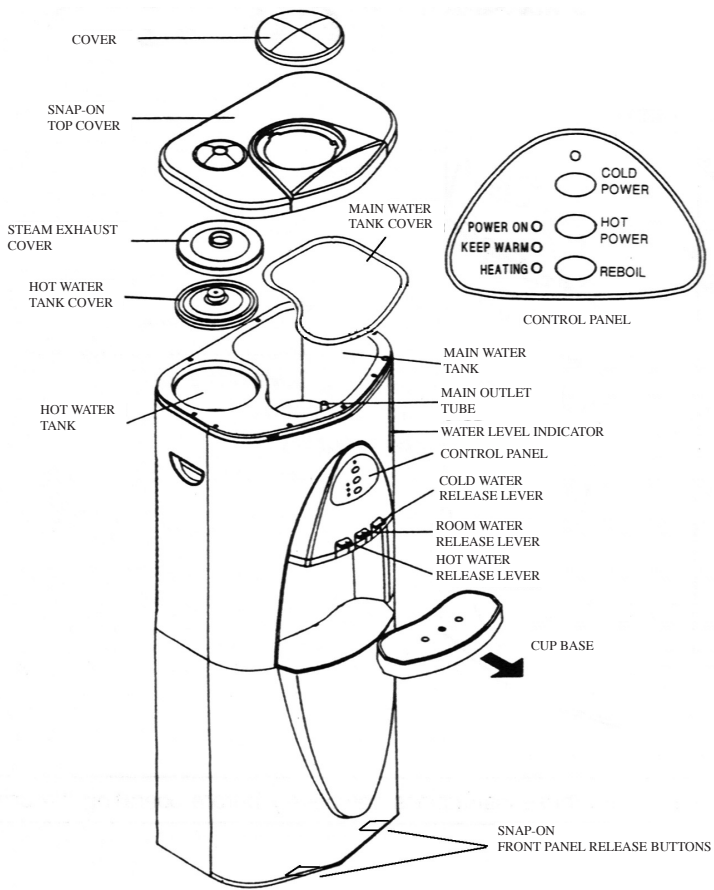

Figure 1 Assembly Drawing PWC 2000 & PWC 3500

The internal flow of water to the tanks and dispensers is shown in Figure 2. The arrangement of the water filter system in the bottom of the cabinet is shown in Figure 3. This is where ordinary city or well water is converted into good tasting, clean, safe drinking water.

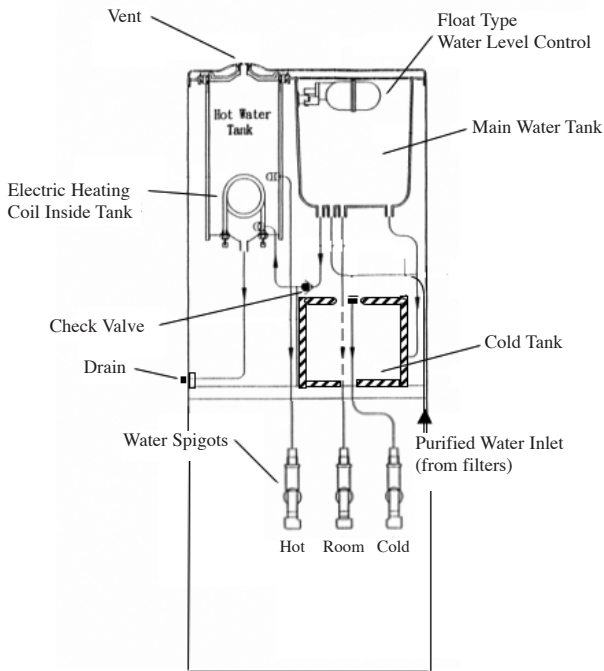

Figure 2 Flow Schematic (Model 2000 & 3500)

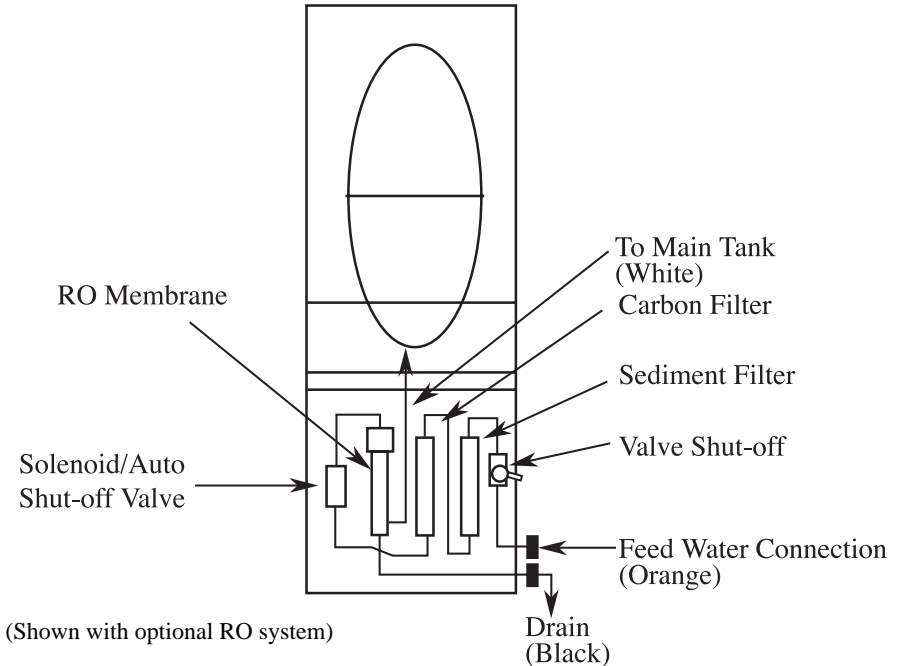

Figure 3 Filtration Schematic. Front of cooler with panel removed.

3.2 Positioning the Cooler

There are some precautions in locating and using the *PureWaterCooler™*. See the items in Figure 4 below. In addition, the cooler must be located near the supply water, and for the “R” version with reverse osmosis filter, there must be access to a drain trap to which the reject water from the RO is delivered. Normally, this can be found in a bathroom, or kitchen sink. Flexible 1/4-inch plastic tubing may be used for the feed and discharge connections. Normally, these connections should be within 25-feet of the cooler.

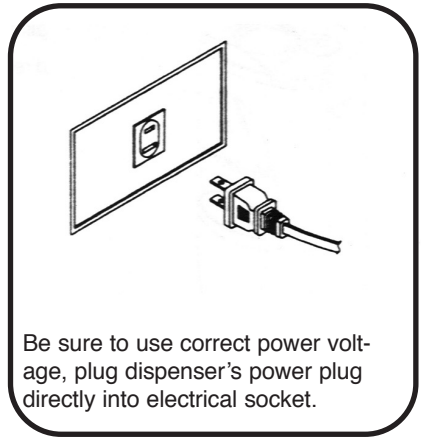
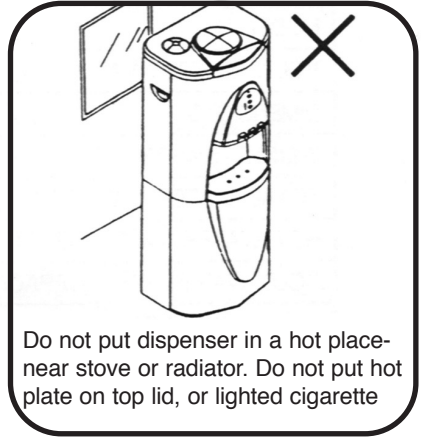
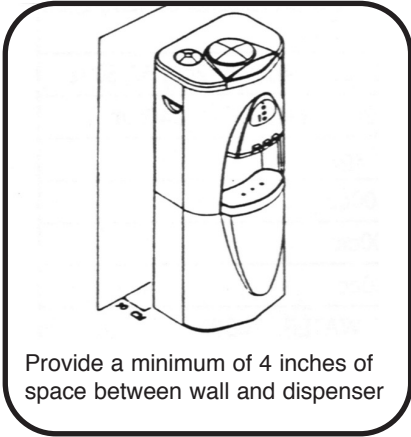

Figure 4 Installation Precautions

3.3 Cooler Water Connections

(See Fig.5) When received, the water connections on the back have color coded tube sections with red shipping plugs in them. These tube sections must be removed before making water connections. To remove the tube sections see figure 7 “Disconnect”. The 1/4" plastic tubing should be used for making the Feed Water and Drain connections. If hard copper tubing is used for the Feed Water and Drain connections the bulkhead fittings must be changed to a metal fitting.

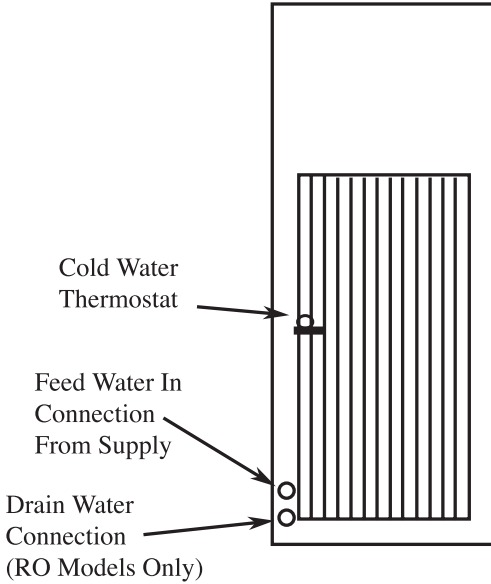
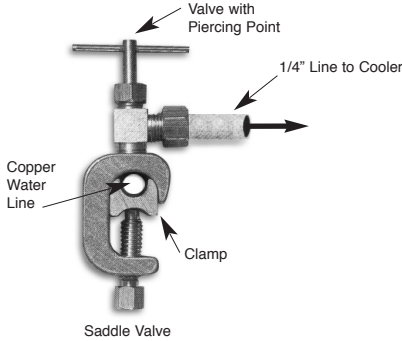

Figure 5 Back View of Cooler Water Connections

3.4 Feed Water Connections

To connect the feedwater, use the supplied self-piercing saddle valve to connect to the cold water supply line under the sink. Attach the 1/4-inch tubing to the compression fitting on the side of the valve. Clamp the saddle valve over copper or plastic feed line (cold water only). Turn the handle on the valve until the needle stem pierces the tube. Then retract the needle 1-2 turns to start water flow. See Photo inset.



3.5 Drain Connection (Applies to all models with Reverse Osmosis (R-version))

The black drain line in the back (Fig. 5) must be hooked to the drain line ahead of the normal sink water trap.

See Figure 6 below. Place the 2 part drain saddle on the drain pipe before the drain trap. Allow proper space for the drilling operation. Tighten the saddle bolts evenly on both sides. Using the opening in the drain outlet saddle as a guide, drill a 1/4" hole in the drain pipe. Clean any debris out of the drain saddle connection. Connect the drain line to the cooler using the 1/4" black tubing supplied.

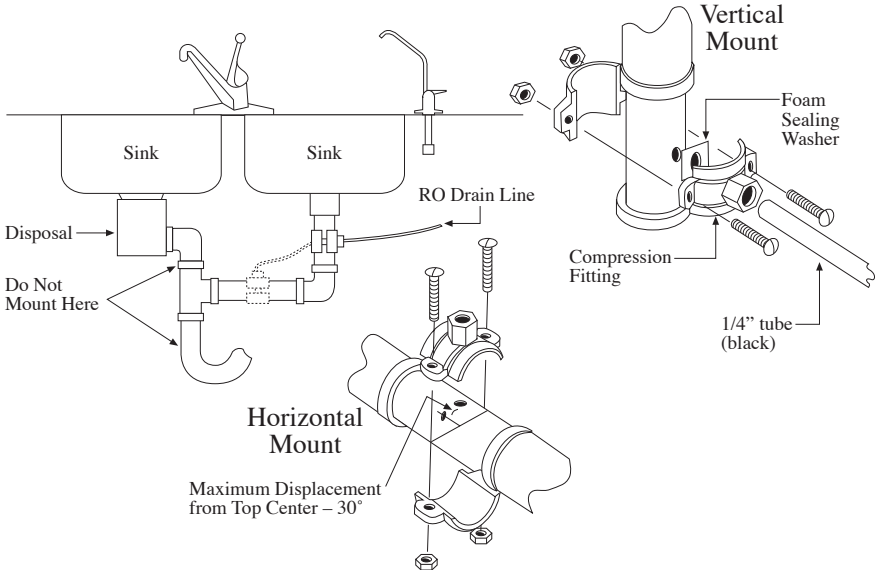
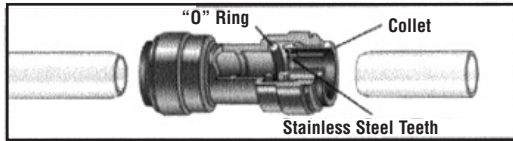

Figure 6 Drain Connections for RO filter

The standard tubing connections on the *PureWaterCooler™* are of quick-connect o-ring seal design. Use the tubing and follow the instructions below in Fig. 7 to make the connections. If you cut the tubing, make sure it is a square cut, fits squarely in the fitting and seals properly.

Cut the tube square.



Cut the tube square. It is essential that the outside diameter is free of score marks and that burrs and sharp edges be removed before inserting into fitting. For soft thin walled plastic tubing we recommend the use of a tube insert.

Insert tube

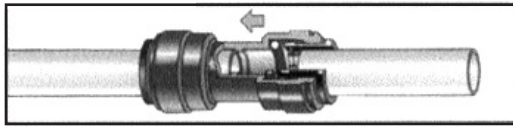

Fitting grips before it seals. Ensure tube is pushed into the tube stop.

Push up to tube stop

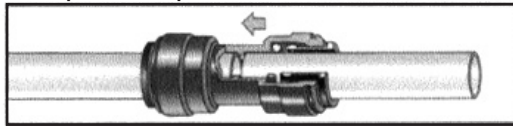

Push the tube into the fitting, to the tube stop. The collet (gripper) has stainless steel teeth which hold the tube firmly in position while the "O" ring provides a permanent leak proof seal

Pull to check secure

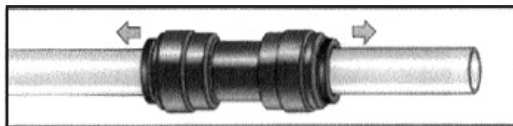

Pull on the tube to check it is secure. It is good practice to test the system prior to leaving site and/or before use.

Disconnect

Push in collet and remove tube

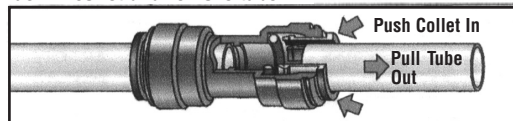

To disconnect ensure the system is depressurized before removing fitting. Push in collet squarely against face of fitting. With the collet held in this position, the tube can be removed. The fitting can then be re-used.

Figure 7 Quick Connect Fittings

4.0 Operation

4.1 Start-Up

Remove front cover by depressing lock tabs on front panel (see fig.1) and pulling forward. With the front cover off, turn the water on at the piercing valve. This brings water to the ball valve. Disconnect the orange tubing from the bottom of the 2nd stage carbon filter and place a pan or bucket underneath the filter to catch water. Open ball valve inside the cooler 1/4-turn (handle in line with tube is "on"), and let water flow through filters into the bucket or pan to push out air and carbon fines. When water runs clear, turn off ball valve and re-connect the orange line to the filter .

Turn on the water to the filter system by opening the ball valve inside the cooler 1/4-turn (handle in line with tube is "on"). Check all connections to assure there are no leaks.

Remove the top cover of the *PureWaterCooler™*. Pull the cover off, exposing the main tank cover. Remove this cover to expose the inside of the main tank. Plug in the power cord to 115-volt wall socket to activate the solenoid shut-off valve- you should hear an audible click. **CAUTION. DO NOT PUSH ANY HOT OR COLD POWER CONTROLS ON YET.**

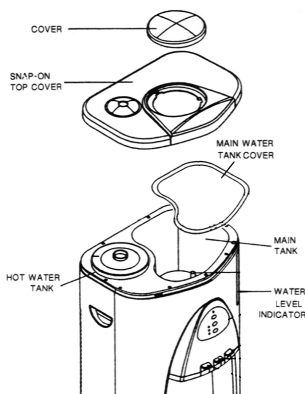

Water will flow into the main tank and then the cold and hot tanks as well. Let cooler tanks fill with the filtered water until full - about 2-hours for the 'R' version, about 10-15 minutes for the 'F' version.

Observe the water level when full, and see that water input to the tank stops when it is full. The solenoid valve will click off as well.

4.2 Tank Flush

Flush tanks out by draining all water through the (2) drain plugs located on the back of the cooler. Let the tanks fill again with the filtered water. When full, drain water again through the drain ports located on the back as well as through the dispensing spigots. When the tank has filled again automatically with filtered water the cooler is ready to dispense water.

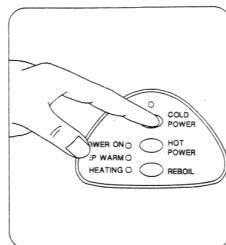

4.3 Power Controls, Cold Water Function

With the water level indicator showing the main tank full, start operation by producing cold water first. Drain some water from the cold tank through the dispensing spigot, to remove entrapped air-you may have to do this several times. Then press the “Cold Power” button on the front panel. The compressor will start and water will start chilling. **CAUTION: IF YOU TURN COLD POWER OFF, WAIT AT LEAST 3-MINUTES BEFORE TURNING IT ON AGAIN.** This is to protect the compressor from being damaged.

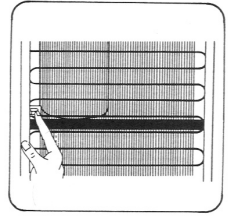

CAUTION: IF THE POWER IS UNPLUGGED WHILE OPERATING, WAIT 10-MINUTES AFTER THE POWER IS PLUGGED IN BEFORE PRESSING THE COLD POWER BUTTON.

4.4 Hot Water Safety Lock

The HOT WATER FAUCET is supplied with a safety lock. The red tab must first be lifted up then the lever underneath depressed to dispense hot water.

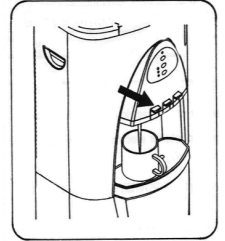

4.5 Dispensing

To obtain hot, warm or cold water, place cup or glass onto cup base directly under desired water type. Press down release lever for water to flow until cup or glass is full.

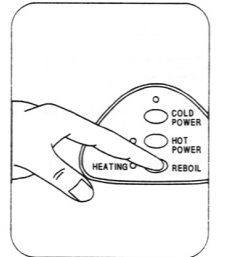

4.6 Hot Water Function

To activate hot water press the HOT POWER button. **CAUTION: MAKE SURE THERE IS WATER IN THE HOT TANK AND IT CAN BE DISPENSED FROM THE FAUCET BEFORE TURNING ON HOT POWER.** Check by opening the hot water spigot to see that water runs out of the spigot.

The POWER ON indicator will light up and heating starts automatically

Once water reaches set temperature the indicator lights on the control panel will switch from “HEATING” to “KEEP WARM”.

The hot water tank refills and the water is re-heated at varying intervals automatically, ensuring a continuous supply of hot water.

When hotter water is needed (up to 212°F) press the REBOIL button. The REBOIL cycle will stop automatically two minutes later and the indicator lights will return to KEEP WARM. (2000 Models only)

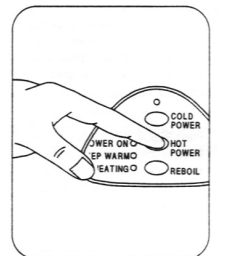

5.0 2-Temp Models Description

5.1 Models 500/1000/1010/1500/1800

The Model 1000 provides water at 2-temperatures, dispensed from two spigots, “hot” and “cold”. The assembly drawing is shown in Figure 8. Water flows from the filter system into the top tank which is also the cold water tank. This tank then feeds the hot tank by gravity. The level in the cold water tank is controlled by a valve and float ball assembly in the tank. The Model 1010 provides only cold & room temperature water. Both models are available with reverse osmosis (R) or standard filter (F) versions.

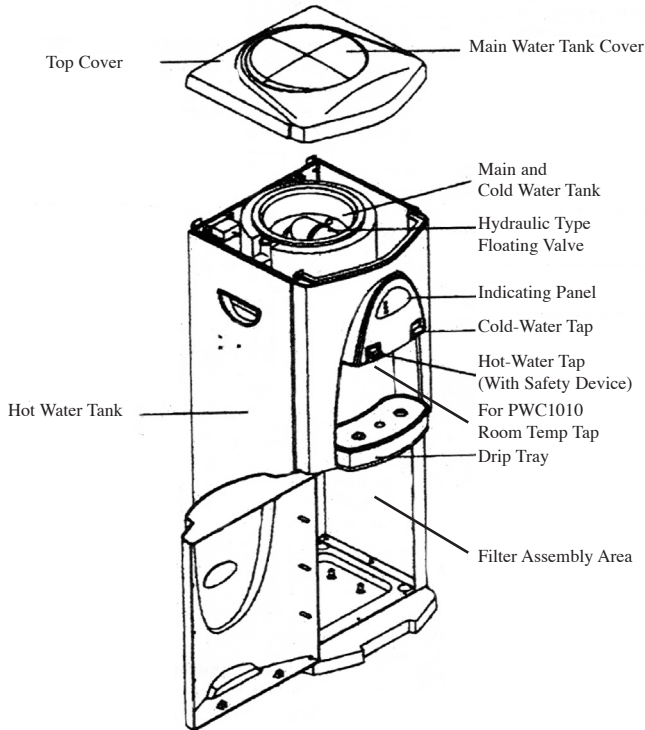

Figure 8 Model 1000 Assembly

5.2 Position Cooler - Same procedure as for Model 2000 (see 3.2)

5.3 Water Connections

Fig. 9 shows the back of the 1000 cooler which has the same water connections as the 2000 Model. Note that there are separate hot and cold power switches to turn on for operation. There is no front control panel in the 1000 model. There are three LED indicators which included.

- Hot power on
- Cold power on
- Heating is in Progress

5.4 Start-Up Flush

Open lower front door to access filter assembly, turn the water on at the piercing valve. This brings water to the ball valve. Disconnect the orange tubing from the bottom of the 2nd stage carbon filter and place a pan or bucket underneath the filter to catch water. Open ball valve inside the cooler 1/4-turn (handle in line with tube is “on”), and let water flow through filters into the bucket or pan to push out air and carbon fines. When water runs clear, turn off ball valve and re-connect the orange line to the filter .

Turn on the water to the filter system by opening the ball valve inside the cooler 1/4-turn (handle in line with tube is “on”). Check all connections to assure there are no leaks. **CAUTION. DO NOT TURN ON HOT OR COLD POWER CONTROLS YET.**

Remove the top cover of the *PureWaterCooler™* by removing 2 screws from back of top cover. Pull the cover off, exposing the main tank. The 1000 & 1010 unit use a mechanical float valve to control flow to the tank. The unit does not have to be plugged in to start water flow.

Water will flow into the main tan/cold tank and then the hot tank as well. Let cooler tanks fill with the filtered water until full - about 2-hours for the ‘R’ version, about 10-15 minutes for the ‘F’ version.

Observe the water level when full, and see that water input to the tank stops when it is full.

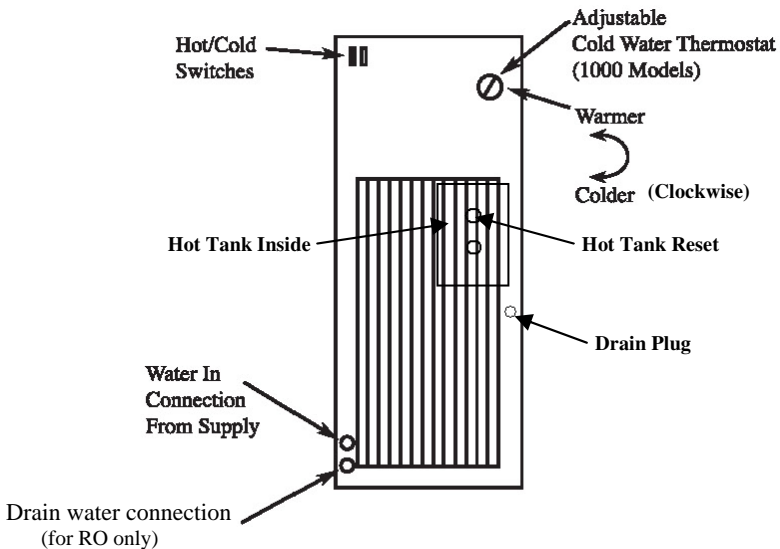

Figure 9 Back view of Cooler Water Connections Models 1000/1010/1500/1800

5.5 Tank Flush

Flush tanks out by draining all water through the (1) drain plug located on the back of the cooler. Let the tanks fill again with the filtered water. When full, drain water again through the drain ports located on the back as well as through the dispensing spigots. When the tank has filled again automatically with filtered water the cooler is ready to dispense water.

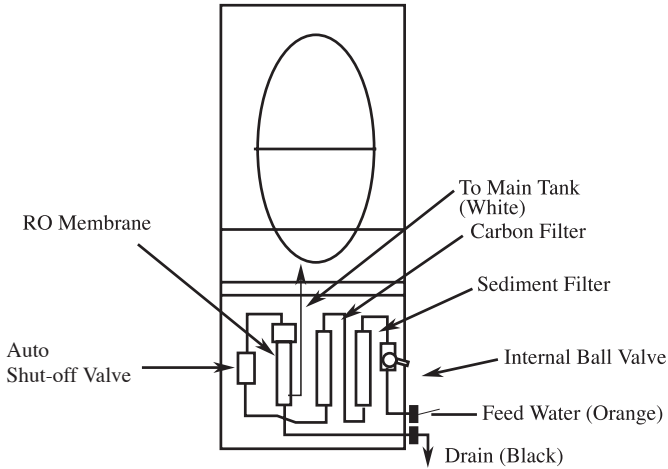

Figure 10 Front of Model 1000 cooler with door opened
(Shown with optional RO system)

6.0 Other Models

6.1 Model 500

This is a countertop version of the Model 1000, a 2-temperature cooler previously described in section 5.0. It does not have space for the filter package, therefore purified water must be supplied to it. An optional filter which can be attached to the back of the unit can be ordered. (Option FP) This filter system has sediment and 2-carbon stages.

6.2 Model 600

This is a countertop version of the Model 2000, 3-temperature cooler previously described In Section 3.0. It does not have space for the filter package, therefore purified water must be supplied to it. An optional filter for the back of the unit can be ordered as noted above.



Model 500



Model 600

ADDENDUM

PWC-1800

1. Model PWC-1800

The model PWC-1800 provides water at 2 temperatures, hot and cold, dispensed from one spigot. The assembly drawing is shown in the figure below. Water flows from the filtration system into the top tank which is also the cold water tank. This tank then feeds the hot tank by gravity. The level in the cold tank is controlled by a valve and float ball assembly in the tank. The PWC-1800 is available with reverse osmosis (R) or standard filter (F) versions.

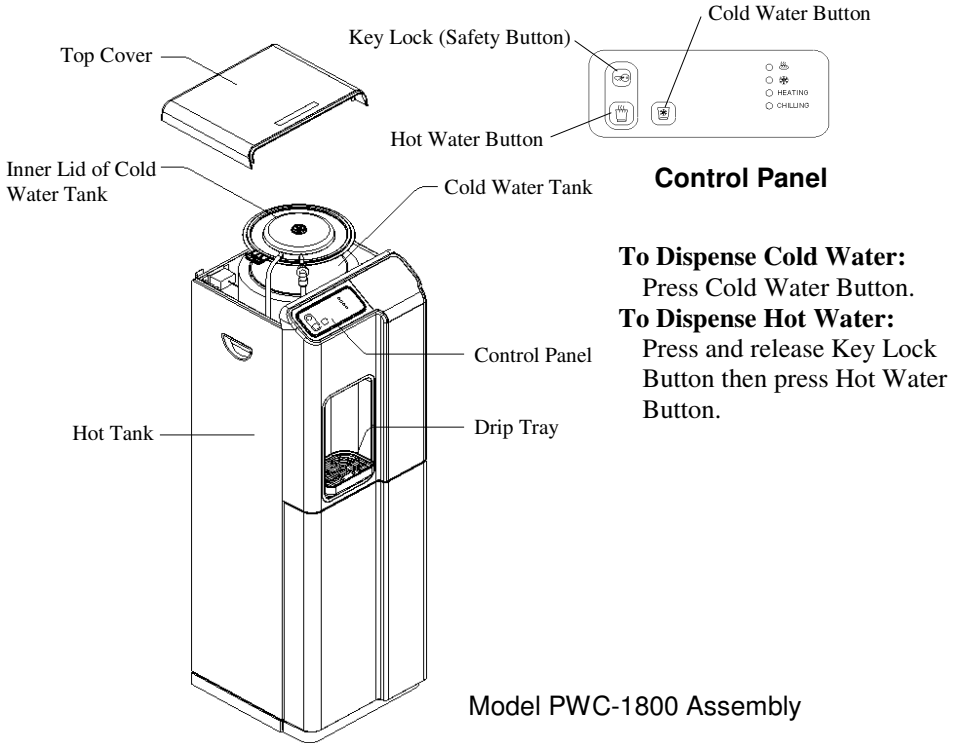

2. Placing Cooler - Same as for Model PWC-2000 (see sec. 3.2)

3. Water Connections

The figure at the top of the next page shows the back of the PWC-1800 cooler. The PWC-1800 has the same water connections as the PWC-2000 Model (see sec. 3.3 - 3.5).

4. Power Control

There are separate hot and cold power switches to turn on for operation located on the back of the cooler. There are four LED indicators on the control panel which include:

- Hot Power On
- Cold Power On
- Heating
- Chilling

4. Start-up Flush - Same as for Model PWC-1000 (see sec. 5.4)

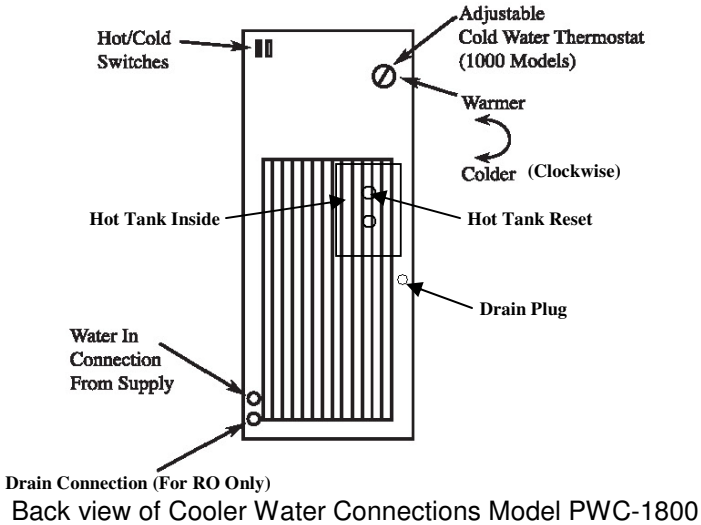

5. Tank Flush

Flush tanks out by draining all water through the drain plug located on the back of the cooler. Let the tanks fill again with the filtered water. When full, drain water again through the drain ports located on the back as well as through the dispensing spigot. The dispense function will only work if the cooler is plugged in. When the tank has filled again automatically with filtered water, the cooler is ready to dispense water.

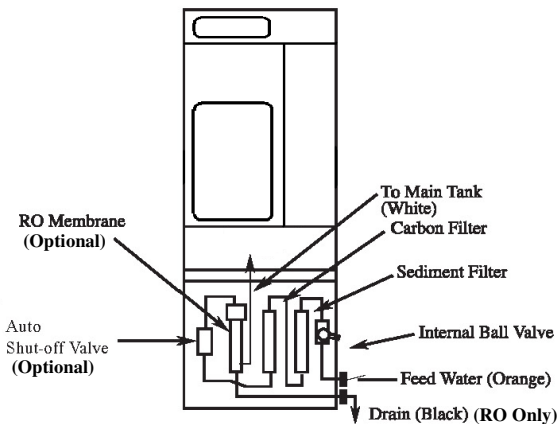

Front of Model PWC-1800 cooler with door opened

Shown with optional RO system

6. Filter Change - See Section 8.0

7.0 Options

Options/Accessories to the cooler are described below.

7.1 UV Stage

An additional stage after the filters is available for all models. The UV stage provides a UV light which disinfects the water. This option is installed at the factory as an additional stage of the filter system. The UV light must be replaced once per year.

7.2 Automatic Sanitization Module

This module generates ozone from the air and dispenses the ozone into the water tank periodically on a time cycle to sanitize the system. This option (OZ) is also installed at the factory.

7.3 Filter Backpacks for Models 500/600

These models do not have space for built-in filtration and require a supply of filtered water. The backpack filter option (FP) attaches to the back of the cooler and will take tap water and filter it. Reverse Osmosis is not available in this option. It is installed at the factory.

8.0 Filter Replacement

The filter elements must be replaced at regular intervals to maintain the quality of the water.

The 1000F, 1010F, 2000F and 3500F versions have 2-stages of mechanical filtration. A 1st stage 5-micron sediment filter and a 2nd stage activated carbon filter. The filter elements in both stages must be replaced every 6-12 months.

The 1000R, 1010R, 2000R and 3500R models have the 2-stages of mechanical filtration plus an additional Reverse Osmosis membrane element. The 2 pre-filters must be replaced every 6-12 months. The Reverse Osmosis membrane must be replaced every 2-3 years.

8.1 Replacement Procedures, Filtration Versions

- a) Remove the lower front panel of the 2000 or 3000 cooler (swing open the front hinged cover on 1000 models).
- b) Close the ball valve to stop water flow through the filters.
- c) Place a pan under the filters to catch water. The filters will have water in them which will run out when the tubing connections are broken.
- d) Disconnect tubing—inlet and outlet for each of the 2-filters.
- e) These filters are disposable, encapsulated filters. Remove and discard entire filter body. Replacement filters are:

1st Stage sediment filter	P/N IFA-4035
2nd Stage carbon filter	P/N IFA-4034

- f) Place new filters in the plastic holding clips. Make the tubing connections into the fittings. **BUT DO NOT CONNECT THE OUTLET TUBING OF THE 2ND STAGE CARBON FILTER.**
- g) Open ball valve and let water flow through filters into a bucket or pan to push out air and any carbon fines. When water runs clear, turn off ball valve and connect 2nd stage filter to outlet line (orange).
- h) After all connections are made, turn on ball valve and water flow to the water dispenser will resume. Wait a few minutes to assure there are no leaks. Replace front panel.

8.2 Stage 3 Reverse Osmosis membrane replacement, RO versions (R) (every 2-3 years)

- a) Use the same procedure as in para. 8.1 above sec a-d.
- b) Remove the RO stage from the clips. Disconnect the orange tubing from the RO housing cap.
- c) Remove the cap from the housing by unscrewing it.
- d) Using a pair of pliers, remove the RO element from the housing by grasping the tube end and pulling it out.
- e) Use RO filter replacement P/N ma-4203 (50gpd TFC membrane). Insert the element into the housing with double “o”-ring end going in first—toward the bottom of the housing. Make sure the “o”-rings are sealed. Replace the cap. Reconnect the orange tubing. Proceed as in para. 8.1, h.
- F) Model PWC-3500 uses RO filter replacement P/N mh-4206 (75gpd TFC encapsulated Membrane). This membrane is disposable, the housing and membrane are integrated. To replace simply disconnect the tubing from the 3 quick connect fittings, (See pg. 9 figure 7) remove membrane from mounting clips and discard old membrane. Install new membrane into mounting clips and re-connect tubing to the quick connect fitting built in membrane housing.

NOTE: For mh-4206 Orange line connects to Green fitting- Feed water in.
 Black line connects to the Yellow fitting - brine water out to drain, White line connects to Blue fitting - clean product water to cooler tank

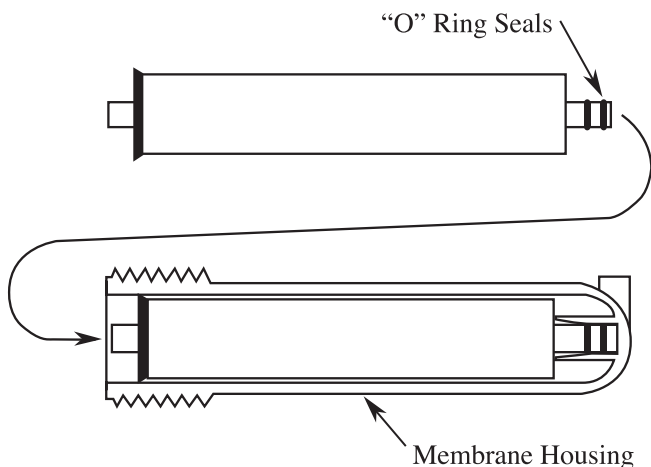
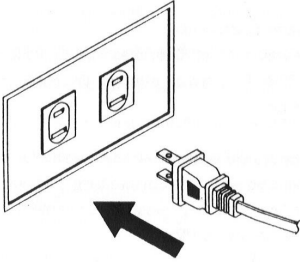

Figure 11 RO Membrane Installation

9.0 Cleaning and Maintenance

These instructions apply to the model 2000, 3500 and 600 specifically, but can be applied to other models.



9.1 Before cleaning water dispenser make sure that power cord is pulled out of socket

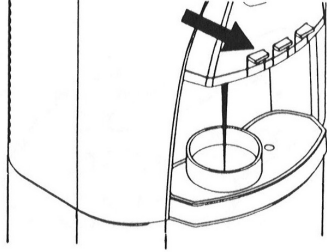

9.2 Remove the top cover, hot water tank cover and the water outlet tube on main water tank. Drain all remaining water inside hot water tank and main water tank by pressing hot and warm water release levers. Use a deep bowl to catch water flowing from valves. Clean main water tank. Sanitize as in section 9.4.

9.3 Unscrew or pull the cap of the water outlet to release all remaining water inside cold water tank.

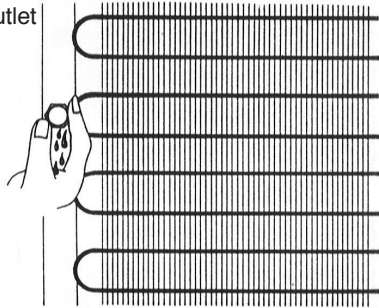

9.4 Sanitize

Fill main water tank with water. Add 1-2 teaspoons of liquid chlorine bleach. Let stand for 5-10 minutes. Drain the water as in 9.2 and 9.3, then let water from filters refill tank and drain a second time.

Note: Upon completion of cleaning, wait at least 10 minutes after the power cord is plugged in before pressing the COLD WATER button

10.0 Trouble Shooting

PROBLEM	CAUSE	SOLUTION
No Power	<p>No electric current flowing.</p> <p>Unit shuts off power automatically when main water tank is empty.</p> <p>Resumption of electric current after a power failure - if unit wasn't unplugged during power failure, unit will not turn on by itself.</p>	<p>Check sockets/outlet for electric current. Check plugs, power cords for improper connections.</p> <p>Fill main water tank with water and press HOT POWER button and/or COLD POWER button to activate dispenser.</p> <p>Press HOT/COLD POWER buttons to activate dispenser.</p>
Water keeps on boiling (Model 2000)	REBOIL button was pressed several times	Press REBOIL button again only once. Observe the dispenser. If problem still occurs, the defect might be in the temperature control device. In this case send unit to local distributor for repair.
Heating cycle is more frequent than normal.	Too little water in hot water tank.	Refill main water tank.
Cold Water not cold enough.	<p>The dispenser is placed too close to wall.</p> <p>Wire Condenser on backside is dusty</p> <p>Unit is placed in poorly ventilated area.</p> <p>Compressor does not have enough refrigerant.</p>	<p>Provide a minimum of 4 in. space between wall and back of dispenser.</p> <p>Clean wire condenser every three months.</p> <p>Place dispenser in a well-ventilated area.</p> <p>Send the dispenser to local distributor.</p> <p>Adjust Thermostat</p>
Cold water doesn't flow out of spigot.	Air may be entrapped in line.	Work the spigot up & down a few times.
Won't Cool	Controls not set.	<p>1000 - Turn cold temp switch "on" at back</p> <p>2000 - Push cold power button on front.</p>
Panel not lit	No Power	Check that power cord is in socket, Then press cold power.
No hot water at start up (2-Temp models and 3500)	Hot tank Overheat protection sensor tripped	<p>1. turn off hot power</p> <p>2. let sensor cool down 45min to 1 1/2 hr.</p> <p>3. reach through cooling grill with pencil or narrow screwdriver to press black reset button on upper sensor located on hot tank (see diag. fig. 9)</p>

Note - In the event of problems beyond the scope of the troubleshooting described in the manual, please call your selling dealer. Vertex sells to dealers who are experts in installation and maintenance.

11.0 Specifications

Model No.	PWC 2000/600	PWC-3500
Voltage/Frequency	AC110V	AC110V
Dimensions	(L)13 x (W)16 x (H)41	(L)16 x (W)16 x (H)42
Weight (empty)	42 lb.	52 lb.
Room Temperature Tank	2.2 gal.	2.2 gal.
Hot Water Tank Capacity	.55 gal.	.8 gal.
Cold Water tank Capacity	.5 gal.	1 gal.
Power Consumption	Hot Water: 500W	Hot Water: 500W
	Cold Water: 100W	Cold Water: 100W
Electric Power Cord Length	6Ft.	6Ft.

Model No.	PWC 500/1000/1500/1800
Voltage/Frequency	AC110V
Dimensions	(L) 13 x (W) 16 x (H) 40
Weight (empty)	42 lb.
Hot Water Tank Capacity	.5 gal.
Cold Water tank Capacity	1.0 gal.
Power Consumption	Hot Water: 500W
	Cold Water: 100W
Electric Power Cord Length	6Ft.

Specification for Model no. PWC 1010 same as above, except there is no hot water.

LIMITED WARRANTY

Vertex Water Products (“Manufacturer”) sell its products through independent retailer dealers (“Dealer”) who re-sell to the end-user customer. In this limited warranty, “Vertex” refers to Vertex Water Products and not to the Dealer.

WHO IS COVERED BY THIS WARRANTY

This limited warranty covers only the first purchaser of the Vertex *PureWaterCooler*™ from a Dealer for use by that purchaser, and is not transferrable. “Consumer Use” means personal residential household use by a consumer or consumers. “Commercial Use” means all other uses, including (but not limited to) use for commercial, income producing purposes and/or when purchased by a business and/or when purchased for use in an office, business, or industrial setting. “Purchaser” means the end-user customer, and not a Vertex re-seller Dealer.

PERIOD OF COVERAGE OF THIS WARRANTY

Manufacturer warrants the complete water cooler (“the unit”) against defects in material and workmanship, subject to the exclusions described below, for a period of ONE YEAR, beginning on the later of either (a) the date of purchase or (b) the date of manufacture as identified by the Vertex unit’s serial number. Manufacturer additionally warrants the compressor for a period of THREE YEARS from the above date. The purchaser must provide the original sales receipt as proof of the date of purchase. If the purchaser is unable to produce the original sales receipt, the Warranty Period commencement date will be determined by Manufacturer, in its sole and absolute discretion, based upon the unit’s serial number. This warranty does not apply if the original serial number affixed by Manufacturer is removed, defaced, altered, obscured, tampered with, or obliterated. If Manufacturer provides a replacement part or parts, or repairs a part or parts, under this limited warranty, then the replacement part(s) or repaired part(s) will be covered under this limited warranty for the time remaining under the original Warranty Period applicable to the part(s) repaired or replaced.

The duration of **ALL OTHER WARRANTIES, INCLUDING ANY AND ALL IMPLIED WARRANTIES, INCLUDING BUT NOT LIMITED TO MERCHANTABILITY AND FITNESS FOR A PARTICULAR PURPOSE, ARE RESTRICTED TO THE TWO-YEAR LIMITED WARRANTY PERIOD.** Some states do not allow limitations on how long an implied warranty lasts, so the above limitation may not apply to purchaser.

WHAT IS COVERED BY THIS WARRANTY

This limited warranty covers defects in materials or workmanship, subject to the exclusions below and for the time period stated above. Manufacturer promises to repair or to replace, at Manufacturer’s sole and absolute discretion, any part of this water cooler that proves to be inoperative due to a defect in material or workmanship under normal use.

WHAT IS NOT COVERED BY THIS WARRANTY

This limited warranty does not extend to and expressly excludes:

- conditions, losses, malfunctions, or damages not resulting from defects in material or workmanship;
- conditions, malfunctions, losses, or damages or the inability to operate the Vertex unit resulting from conditions beyond Manufacturer’s control, including but not limited to failure of the unit or any of its parts due to damage caused by: improper installation; accident; fire; flood; windstorm; acts of God; rodent and/or insect infestation; vandalism; modification; alteration; combination with any other device or machine; abuse and/or misuse of the unit; negligence by purchaser or third parties; any part of the water system that has become fouled due to liming, dirt, unsatisfactory/unsanitary water conditions, corrosion, or faulty plumbing; failure to install, maintain, assemble, mount or place the Vertex unit in accordance with Manufacturer’s instructions and/or local, state, or national plumbing and electrical codes; wear and tear expected to occur in the normal course of use, including but not limited to cosmetic rust, scratches, dents or comparable and reasonably expected losses or damages; exposure to extreme variations in ambient environmental conditions (including but not limited to changes in heat, humidity, moisture, or exposure to sunlight).
- labor for installation or deinstallation of the unit or any of its parts; shipping of the unit or any of its parts to Manufacturer for repair/replacement.

In addition to the above exclusions, this limited warranty does not apply if any of the following conditions of operation are not met: System Pressure 35 - 100 psi, Temperature 40 - 100 degrees F, PH range 4 - 10, Max TDS 1500 PPM Max., Turbidity <1.0NTU, Hardness <20gpg, R version: <3.5 gpg, F version, Iron <0.1 mg/l, Manganese <0.1 mg/l, Hydrogen Sulfid e <0.00 mg/l.

NO OTHER EXPRESS OR IMPLIED WARRANTY APPLIES

This limited warranty is the sole and exclusive warranty provided to the purchaser identified above. No other express warranty, written or verbal, applies. No agent, employee, deal or other person or entity is authorized to alter this limited warranty or make any other warranty on behalf of Manufacturer. The terms of this limited warranty shall not be modified by the Manufacturer, the purchaser/end user, or their respective successors or assigns.

WHAT WE WILL DO TO CORRECT PROBLEMS/ HOW TO GET WARRANTY PARTS

If the Vertex unit does not operate in accordance with the documentation provided to purchaser, or purchaser have questions concerning purchaser Vertex unit, please contact the Dealer from whom the unit was purchased. If the original Dealer is not available or the purchaser does not know who the Dealer is, please call or email the Manufacturer, Vertex, using the contact information provided below. We will try to find a Dealer in purchaser geographical area to assist purchaser. If a Dealer cannot be conveniently located, the Manufacturer, in its sole and absolute discretion, may offer two (2) options. First, we will attempt to troubleshoot the issue with purchaser over the phone. If the purchaser is comfortable making a repair/ replacing a part, once we understand the problem and its solution, we will send the replacement part(s) for the cooler. **This warranty is for the replacement of part(s) ONLY; it does not cover the cost of labor for either the Dealer or the end user/purchaser.** The second option is that the end user/purchaser may, after notifying Manufacturer and receiving written authorization/approval from Manufacturer to do so, send the unit back to Manufacturer and we will repair it. **The end user purchaser must pay the freight/ shipping costs to return the unit to Manufacturer.** Manufacturer will pay the freight/shipping to return the unit to the end user/purchaser following repair.

If the end user/purchaser contacts the Dealer and the Dealer repairs the unit pursuant to this limited warranty, Manufacturer will provide parts to the Dealer at no charge; labor is not included in this limited warranty.

The Dealer may, in his or her sole and absolute discretion, decide to repair the unit on-site or take the unit to a shop to repair.

This limited warranty covers replacement or repair of parts only. Manufacturer will not replace the entire unit if a part can be replaced or repaired to restore the unit to full operational function. On the rare occasion that a unit cannot be restored to full operation by a part or parts, Manufacturer will replace the unit after the end user/purchaser has shipped the unit to Manufacturer and Manufacturer has determined, in its sole and absolute discretion, that the unit cannot be repaired and must be replaced. **The end user/purchaser must pay the freight/shipping costs to return the unit to Manufacturer.** Manufacturer will pay the freight/ shipping to return the unit to the end user/purchaser following repair or will ship a new unit if repair is not possible. If Manufacturer does provide a replacement unit, then the Warranty Period (as specified above) for the replacement unit would begin at the time of its delivery to the end user/purchaser.

LIMITATION OF LIABILITY AND DISCLAIMER OF WARRANTIES

TO THE EXTENT PERMITTED BY LAW, IN NO EVENT SHALL MANUFACTURER BE LIABLE TO PURCHASER OR ANY THRID PARTIES FOR ANY INCIDENTAL, SPECIAL, INDIRECT, OR CONSEQUENTIAL DAMAGES, INCLUDING ANY ECONOMIC LOSS, WHETHER RESULTING FROM NON-PERFORMANCE, USE, MISUSE, OR INABILITY TO USE THE VERTEX UNIT. MANUFACTURER SHALL NOT BE LIABLE FOR DAMAGES CAUSED BY DELAY IN PERFORMANCE AND IN NO EVENT, REGARDLESS OF THE FORM OF THE CLAIM OR CAUSE OF ACTION (WHETHER BASED IN CONTRACT, WARRANTY, TORT, INFRINGEMENT, NEGLIGENCE, STRICT LIABILITY, OTHER TORT OR ANY OTHER LEGAL THEORY) SHALL MANUFACTURER'S ENTIRE LIABILITY EXCEED THE PRICE PAID BY THE ORIGINAL PURCHASER FOR THE VERTEX UNIT. THE TERM "CONSEQUENTIAL DAMAGES" SHALL INCLUDE, BUT NOT BE LIMITED TO, LOSS OF ANTICIPATED PROFITS, BUSINESS INTERRUPTION, LOSS OF USE OR REVENUE, COST OF CAPITAL, OR LOSS OR DAMAGE TO PROPERTY OR EQUIPMENT.

Contact information:

Vertex Water Products 5138 Brooks Street
800-627-2146 www.vertexwater.com

Montclair, California 91763
email: inquiries@vertexwater.com



VERTEX WATER PRODUCTS, Montclair, Calif.

PWCM-1 Rev B.1a • 5/07
Copyright 2015
VERTEX Industrials, Inc.